

## ASSEMBLY AND INSTALLATION INSTRUCTIONS for the 335313XB Fixture

### Important Safety information (Please read before proceeding)

1. Remove the fixture, parts and all mounting hardware bags (orange) from the carton and verify that all parts are present according to the illustration sheet. All parts must be used as indicated. Do not replace any parts, leave any parts out, or use any parts which are worn out or broken. **Failure to follow the instructions could cause a hazardous situation, voids the warranty and violates the U.L. listing of the fixture.**
2. To prevent the electric shock, turn off the main power at the circuit breaker before installing the fixture. **NEVER attempt to install, clean or replace bulbs without shutting off the electricity to the fixture.**
3. **Never use light bulbs with wattage ratings that exceed the fixtures maximum rating.** Always make sure the electric current is turned off before changing the bulbs.
4. If you experience difficulties installing the lighting fixture or it fails to work as expected, please contact a local qualified licensed electrical contractor.
5. Please contact your local Capital Lighting Fixture reseller with any assembly or installation questions. Your local reseller can also provide you with replacement parts for your new fixture.

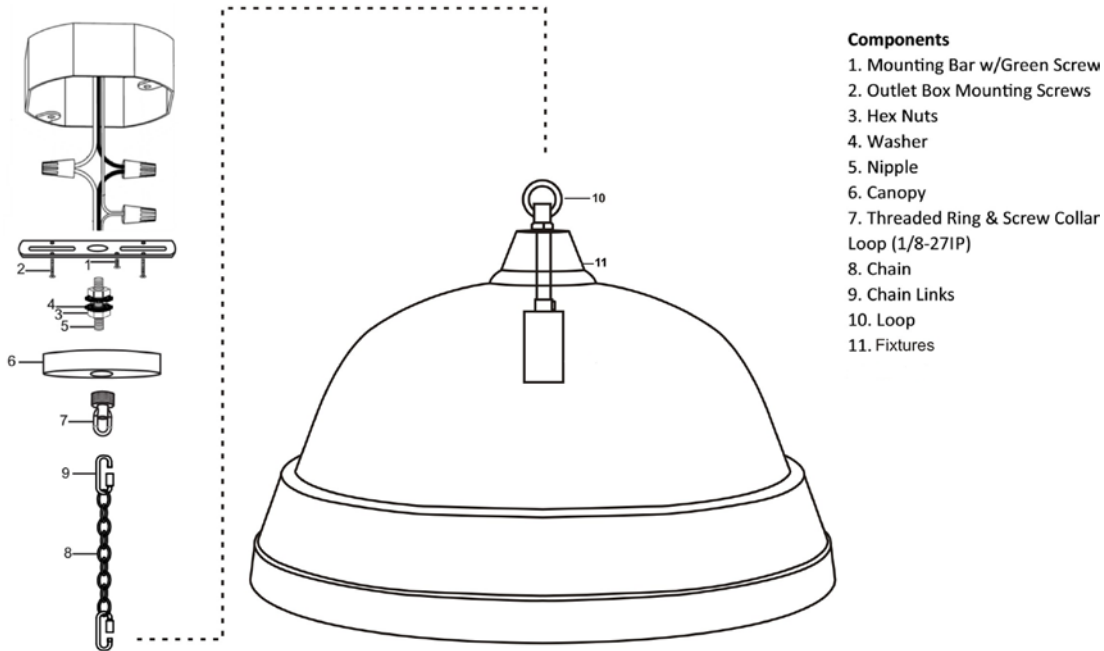

### Assembly Instructions for the 335313XB fixture

1. Pass Lead wire from top of Fixture (11) thru Loop (10), then screw Loop (10) onto nipple end of Fixture Top (11) tightly.
2. Take Nipple (5) from parts bag and screw in Screw Collar Loop (7), and run one Hex Nut (3) with Washer (4) down Nipple (5), then screw Nipple (5) into Mounting Bar (1). Mounting Bar (1) must be positioned with extruded thread faced into Outlet Box. Nipple (5) must protrude out the back of Mounting Bar (1).
3. Attach Mounting Bar (1) to Outlet Box with Outlet Box Mounting Screws (2).
4. Unscrew the Threaded Ring from Screw Collar Loop (7). Take Canopy (6) and pass over Screw Collar Loop (7). Approximately one half of the Screw Collar Loop exterior threads should be exposed. Adjust Screw Collar Loop (7) by turning assembly up or down in Mounting Bar (1). Remove Canopy (6).
5. After desired position is found, tighten Nipple (5) with one Hex Nut (3) onto Screw Collar Loop (7) and tighten another Hex Nut (3) with Washer (4) against the Mounting Bar (1).
6. Slip Canopy (6) over Screw Collar Loop (7) and thread on Threaded Ring. Attach Chain (8) and Chain Link (9) with fixture connected to bottom of Screw Collar Loop (7). Unscrew Threaded Ring, let Canopy (6) and Threaded Ring slip down.
7. Pass lead wire and ground wire through chain links no more than 3 inches apart, then pass wires through Threaded Ring, Canopy (6), Screw Collar Loop (7), Nipple (5) and into Outlet Box.
8. Connect fixture ground wire to the outlet box ground wire with wire connector supplied; connect the common wire of the lamp cord to the power supply white wire with wire connector supplied; connect supply wire of the lamp cord to the power supply black wire with wire connector supplied. *Note: This fixture is wired using 2 conductor Lamp cord. The insula on between the two conductors on the lamp cord can be split down the center for better access to the two conductors. The common wire on the lamp cord is identified as the conductor with ribs embossed in the rubber wire insulation.*
9. Raise Canopy (6) to ceiling, verify all wires are securely inside Canopy (6), then secure Canopy (6) in place by tightening Threaded Ring onto Screw Collar Loop (7).

## ASSEMBLY AND INSTALLATION INSTRUCTIONS for the 335313XN Fixture

### Important Safety information (Please read before proceeding)

1. Remove the fixture, parts and all mounting hardware bags (orange) from the carton and verify that all parts are present according to the illustration sheet. All parts must be used as indicated. Do not replace any parts, leave any parts out, or use any parts which are worn out or broken. **Failure to follow the instructions could cause a hazardous situation, voids the warranty and violates the U.L. listing of the fixture.**
2. To prevent the electric shock, turn off the main power at the circuit breaker before installing the fixture. **NEVER attempt to install, clean or replace bulbs without shutting off the electricity to the fixture.**
3. **Never use light bulbs with wattage ratings that exceed the fixtures maximum rating.** Always make sure the electric current is turned off before changing the bulbs.
4. If you experience difficulties installing the lighting fixture or it fails to work as expected, please contact a local qualified licensed electrical contractor.
5. Please contact your local Capital Lighting Fixture reseller with any assembly or installation questions. Your local reseller can also provide you with replacement parts for your new fixture.

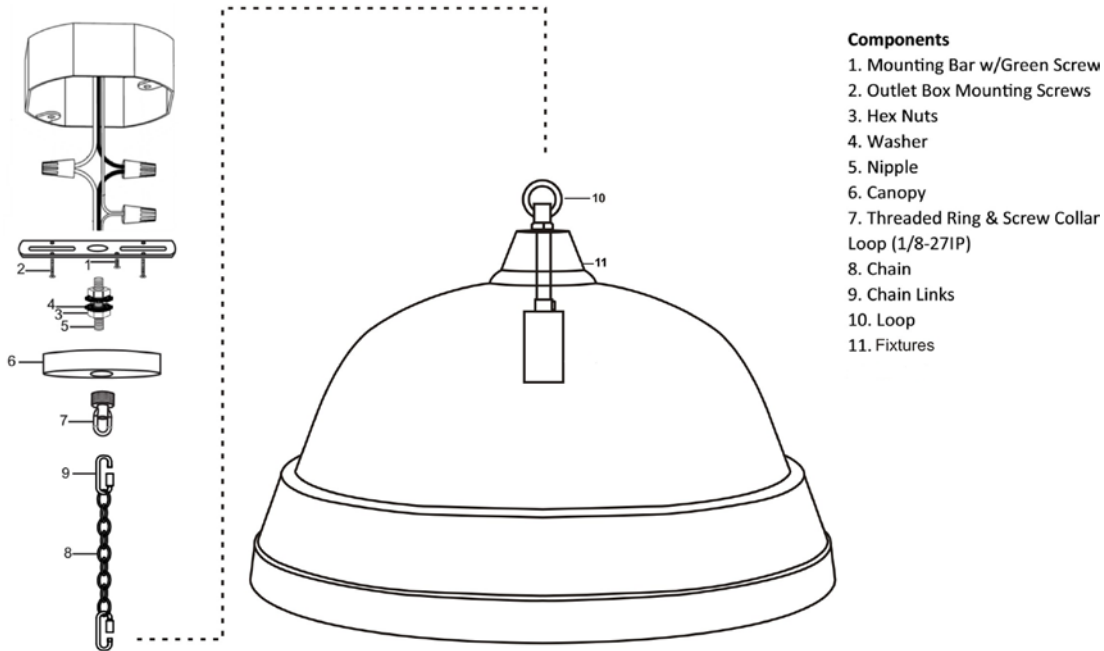

### Assembly Instructions for the 335313XN fixture

1. Pass Lead wire from top of Fixture (11) thru Loop (10), then screw Loop (10) onto nipple end of Fixture Top (11) tightly.
2. Take Nipple (5) from parts bag and screw in Screw Collar Loop (7), and run one Hex Nut (3) with Washer (4) down Nipple (5), then screw Nipple (5) into Mounting Bar (1). Mounting Bar (1) must be positioned with extruded thread faced into Outlet Box. Nipple (5) must protrude out the back of Mounting Bar (1).
3. Attach Mounting Bar (1) to Outlet Box with Outlet Box Mounting Screws (2).
4. Unscrew the Threaded Ring from Screw Collar Loop (7). Take Canopy (6) and pass over Screw Collar Loop (7). Approximately one half of the Screw Collar Loop exterior threads should be exposed. Adjust Screw Collar Loop (7) by turning assembly up or down in Mounting Bar (1). Remove Canopy (6).
5. After desired position is found, tighten Nipple (5) with one Hex Nut (3) onto Screw Collar Loop (7) and tighten another Hex Nut (3) with Washer (4) against the Mounting Bar (1).
6. Slip Canopy (6) over Screw Collar Loop (7) and thread on Threaded Ring. Attach Chain (8) and Chain Link (9) with fixture connected to bottom of Screw Collar Loop (7). Unscrew Threaded Ring, let Canopy (6) and Threaded Ring slip down.
7. Pass lead wire and ground wire through chain links no more than 3 inches apart, then pass wires through Threaded Ring, Canopy (6), Screw Collar Loop (7), Nipple (5) and into Outlet Box.
8. Connect fixture ground wire to the outlet box ground wire with wire connector supplied; connect the common wire of the lamp cord to the power supply white wire with wire connector supplied; connect supply wire of the lamp cord to the power supply black wire with wire connector supplied. *Note: This fixture is wired using 2 conductor Lamp cord. The insula on between the two conductors on the lamp cord can be split down the center for better access to the two conductors. The common wire on the lamp cord is identified as the conductor with ribs embossed in the rubber wire insulation.*
9. Raise Canopy (6) to ceiling, verify all wires are securely inside Canopy (6), then secure Canopy (6) in place by tightening Threaded Ring onto Screw Collar Loop (7).